

K1

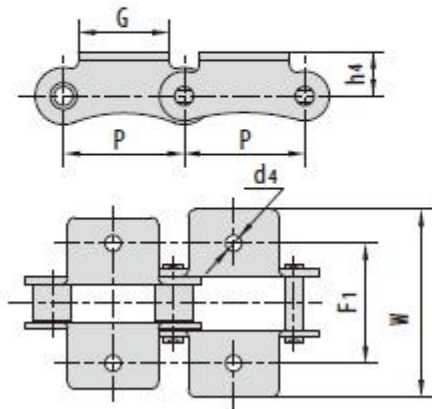

SK1

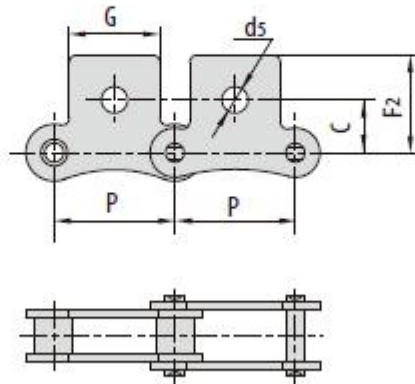

SK2

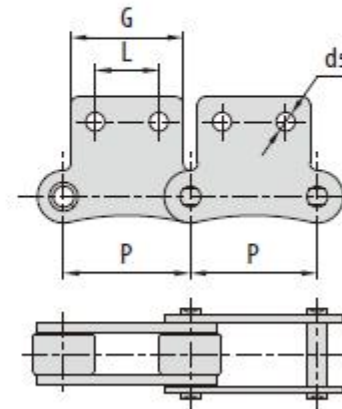



HANGZHOU OCEAN INDUSTRY CO., LTD.

| DIN/ISO 链号 DIN/ISO Chain No. | ANSI 链号 ANSI Chain No. | P | G | F ₁ | W | h ₄ | d ₄ | C | F ₂ | d ₅ |
|---------------------------------------|---------------------------------|-------|------|----------------|-------|----------------|----------------|------|----------------|----------------|
| | | mm | mm | mm | mm | mm | mm | mm | mm | mm |
| 208A | 2040 | 25.40 | 19.1 | 25.4 | 39.6 | 9.1 | 3.4 | 11.1 | 20.5 | 5.5 |
| 210A | 2050 | 31.75 | 23.8 | 31.8 | 49.0 | 11.1 | 5.5 | 14.3 | 25.0 | 6.6 |
| 212A | 2060 | 38.10 | 28.6 | 42.9 | 67.8 | 14.7 | 5.5 | 17.5 | 32.9 | 9.2 |
| 216A | 2080 | 50.80 | 38.1 | 55.6 | 87.8 | 19.1 | 6.8 | 22.2 | 43.5 | 11.0 |
| 220A | 2100 | 63.50 | 47.6 | 66.6 | 107.5 | 23.4 | 9.2 | 28.6 | 50.4 | 13.0 |
| 224A | 2120 | 76.20 | 57.2 | 79.3 | 121.4 | 27.8 | 10.5 | 33.3 | 55.5 | 15.0 |
| 208B | | 25.40 | 23.2 | 25.4 | 39.6 | 9.1 | 4.5 | 11.1 | 20.5 | 5.5 |
| 210B | | 31.75 | 23.8 | 31.8 | 49.0 | 11.1 | 5.5 | | | |
| 212B | | 38.10 | 35.0 | 38.1 | 57.0 | 14.7 | 6.6 | | | |
| 216B | | 50.80 | 44.0 | 50.8 | 84.0 | 19.1 | 6.6 | | | |
| 220B | | 63.50 | 52.0 | 63.5 | 104.0 | 23.4 | 8.4 | | | |
| 224B | | 76.20 | 60.0 | 76.2 | 120.0 | 27.8 | 10.5 | | | |

| Chain No. | P | G | L | F ₁ | W | h ₄ | d ₄ | C | F ₂ | d ₅ |
|------------|-------|-------|-------|----------------|-------|----------------|----------------|-------|----------------|----------------|
| | mm | mm | mm | mm | mm | mm | mm | mm | mm | mm |
| 208BA1F4 | 25.40 | 23.80 | - | 26.20 | 39.40 | 10.00 | 4.30 | - | - | - |
| 2060HK1F26 | 38.10 | 28.60 | - | 42.90 | 67.80 | 14.70 | 8.50 | - | - | - |
| 212BK2F2 | 38.10 | 36.20 | - | 34.90 | 55.50 | 13.00 | 6.20 | - | - | - |
| 212BA0F1 | 38.10 | 50.80 | - | - | 72.80 | 14.70 | - | - | - | - |
| 216BSA2F1 | 50.80 | 45.00 | 25.50 | - | - | - | - | 30.00 | 40.00 | 7.50 |

A1

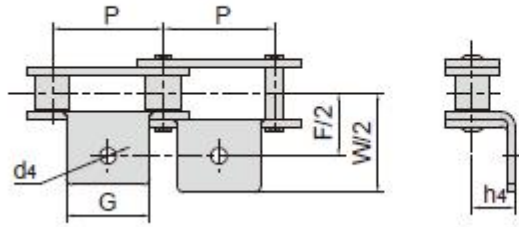

K1

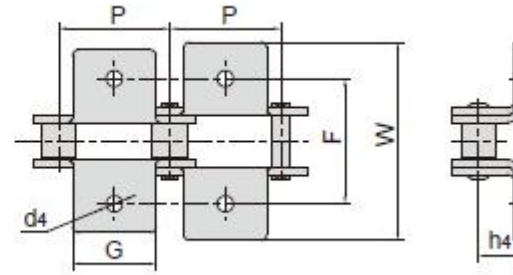

A2

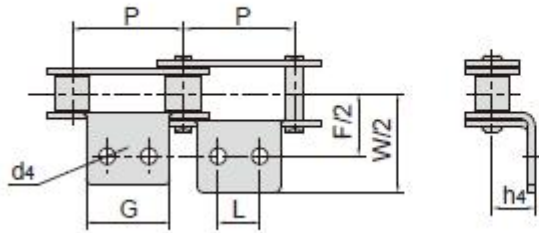

K2

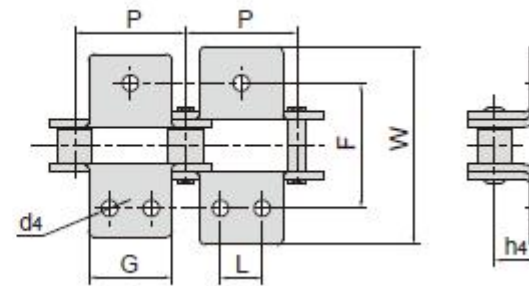



HANGZHOU OCEAN INDUSTRY CO., LTD.

| ISO 链号 ISO Chain No. | ANSI 链号 ANSI Chain No. | P | G | L | F | W | h4 | d4 |
|-------------------------------|---------------------------------|--------|------|------|-------|-------|------|------|
| | | mm | mm | mm | mm | mm | mm | mm |
| C 208A | C 2040 | 25.40 | 19.1 | 9.5 | 25.4 | 39.6 | 9.1 | 3.4 |
| C 208AL | C 2042 | | 23.2 | 12.7 | 25.4 | 39.6 | 9.1 | 4.5 |
| C 208B | | 25.40 | 23.2 | 12.7 | 25.4 | 39.6 | 9.1 | 4.5 |
| C 208BL | | | 23.2 | 12.7 | 25.4 | 39.6 | 9.1 | 4.5 |
| C 210A | C 2050 | 31.75 | 23.8 | 11.9 | 31.8 | 49.0 | 11.1 | 5.5 |
| C 210AL | C 2052 | | 23.8 | 11.9 | 31.8 | 49.0 | 11.1 | 5.5 |
| C 212A | C 2060 | 38.10 | 28.6 | 14.3 | 42.9 | 67.8 | 14.7 | 5.5 |
| C 212AL | C 2062 | | 28.6 | 14.3 | 42.9 | 67.8 | 14.7 | 5.5 |
| C 212AH | C 2060H | 38.10 | 28.6 | 14.3 | 42.9 | 67.8 | 14.7 | 5.5 |
| C 212AHL | C 2062H | | 28.6 | 14.3 | 42.9 | 67.8 | 14.7 | 5.5 |
| C 216A | C 2080 | 50.80 | 38.1 | 19.1 | 55.6 | 87.8 | 19.1 | 6.8 |
| C 216AL | C 2082 | | 38.1 | 19.1 | 55.6 | 87.8 | 19.1 | 6.8 |
| C 216AH | C 2080H | 50.80 | 38.1 | 19.1 | 55.6 | 87.8 | 19.1 | 6.8 |
| C 216AHL | C 2082H | | 38.1 | 19.1 | 55.6 | 87.8 | 19.1 | 6.8 |
| C 220A | C 2100 | 63.50 | 47.6 | 23.8 | 66.6 | 107.5 | 23.4 | 9.2 |
| C 220AL | C 2102 | | 47.6 | 23.8 | 66.6 | 107.5 | 23.4 | 9.2 |
| C 220AH | C 2100H | 63.50 | 47.6 | 23.8 | 66.6 | 107.5 | 23.4 | 9.2 |
| C 220AHL | C 2102H | | 47.6 | 23.8 | 66.6 | 107.5 | 23.4 | 9.2 |
| C 224A | C 2120 | 76.20 | 57.2 | 28.6 | 79.3 | 121.4 | 27.8 | 11.0 |
| C 224AL | C 2122 | | 57.2 | 28.6 | 79.3 | 121.4 | 27.8 | 11.0 |
| C 224AH | C 2120H | 76.20 | 57.2 | 28.6 | 79.3 | 121.4 | 27.8 | 11.0 |
| C 224AHL | C 2122H | | 57.2 | 28.6 | 79.3 | 121.4 | 27.8 | 11.0 |
| C 232A | C 2160 | 101.60 | 76.2 | 38.1 | 104.7 | 151.6 | 36.5 | 13.1 |
| C 232AL | C 2162 | | 76.2 | 38.1 | 104.7 | 151.6 | 36.5 | 13.1 |
| C 232AH | C 2160H | 101.60 | 76.2 | 38.1 | 104.7 | 151.6 | 36.5 | 13.1 |
| C 232AHL | C 2162H | | 76.2 | 38.1 | 104.7 | 151.6 | 36.5 | 13.1 |

A1

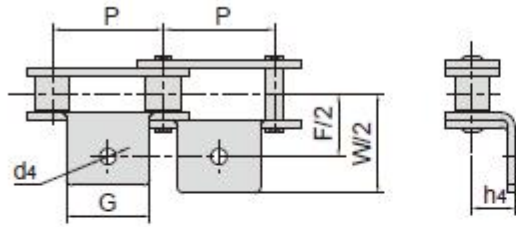

K1

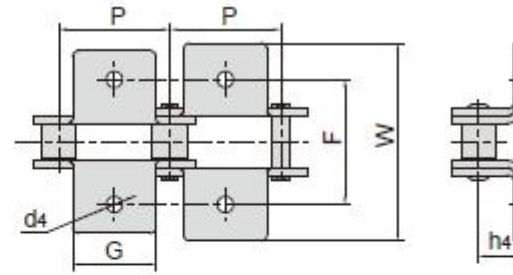

A2

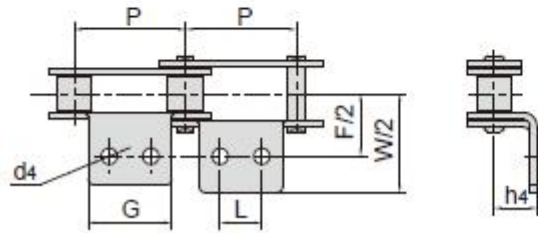

K2

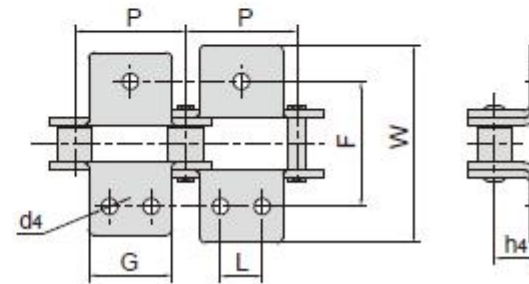



HANGZHOU OCEAN INDUSTRY CO., LTD.

| Chain No. | P | G | L | F | W | h4 | d4 |
|---------------|-------|-------|-------|------|-------|-------|------|
| | mm | mm | mm | mm | mm | mm | mm |
| C 2040A 1F3 | 25.40 | 19.00 | - | 25.4 | 38.20 | 19.80 | 5.30 |
| C 2040A 1F4 | 25.40 | 19.10 | - | 25.4 | 36.20 | 9.10 | 5.00 |
| C 2040A 2F1 | 25.40 | 19.00 | 9.00 | 25.4 | 38.40 | 9.00 | 5.20 |
| C 2040A 2F18 | 25.40 | 19.10 | 9.50 | 25.4 | 39.60 | 9.10 | M 4 |
| C 2040K 1F6 | 25.40 | 19.10 | - | 25.4 | 39.60 | 9.10 | M 5 |
| C 2040K 1F8 | 25.40 | 19.00 | - | 25.4 | 39.60 | 9.10 | 6.50 |
| C 2042A 1F4 | 25.40 | 19.00 | - | 25.4 | 39.60 | 9.10 | 5.00 |
| C 2042F1 | 25.40 | 19.00 | - | 25.4 | 40.00 | 9.00 | 5.20 |
| C 2042HK 1F1 | 25.40 | 19.00 | - | 47.0 | 60.00 | 9.10 | 7.00 |
| C 2042K 2F4 | 25.40 | 20.00 | 12.00 | 26.4 | 35.40 | 9.00 | M 4 |
| C 208A F1 | 25.40 | 19.00 | - | 25.7 | 38.30 | 8.80 | 4.10 |
| C 208BA 1F8 | 25.40 | 14.80 | - | 25.6 | 37.80 | 9.80 | 5.50 |
| C 208BA 2F2 | 25.40 | 23.20 | 12.70 | 25.4 | 39.60 | 9.10 | M 5 |
| C 208BA 2F3 | 25.40 | 23.20 | 9.50 | 25.4 | 39.70 | 9.10 | 4.50 |
| C 208BHK 1F7 | 25.40 | 23.20 | - | 25.4 | 39.60 | 9.10 | 6.50 |
| C 208BK 1F11 | 25.40 | 23.20 | - | 25.4 | 39.60 | 9.10 | 6.50 |
| C 2050A 1F6 | 31.75 | 23.80 | - | 31.8 | 49.00 | 11.40 | 6.30 |
| C 2052A 2F1 | 31.75 | 19.00 | 11.90 | 31.8 | 49.00 | 11.10 | 6.00 |
| C 2052A 2F2 | 31.75 | 19.00 | 15.88 | 31.8 | 49.00 | 11.10 | 5.50 |
| C 2052A 2F3 | 31.75 | 25.80 | 12.70 | 31.8 | 49.20 | 11.10 | 4.80 |
| C 2052K 1F10 | 31.75 | 25.00 | - | 32.5 | 57.00 | 11.10 | 5.50 |
| C 2060A 1F38 | 38.10 | 28.60 | - | 42.9 | 67.80 | 14.70 | 5.50 |
| C 2060A 2F26 | 38.10 | 30.00 | 18.00 | 38.0 | 50.00 | 14.70 | 5.50 |
| C 2060A 2F27 | 38.10 | 30.00 | 18.00 | 44.0 | 62.00 | 14.70 | 5.50 |
| C 2060A 2F93 | 38.10 | 50.00 | 30.00 | 44.0 | 63.00 | 30.00 | 9.00 |
| C 2060HA 1F12 | 38.10 | 28.00 | - | 43.4 | 61.80 | 13.90 | 6.60 |

A1

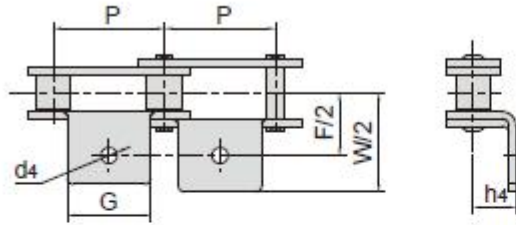

K1

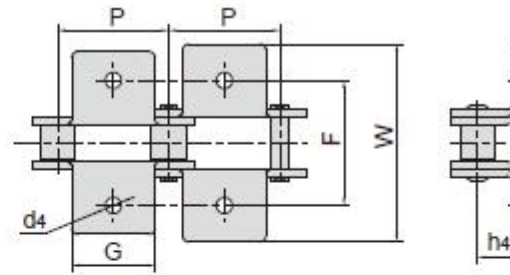

A2

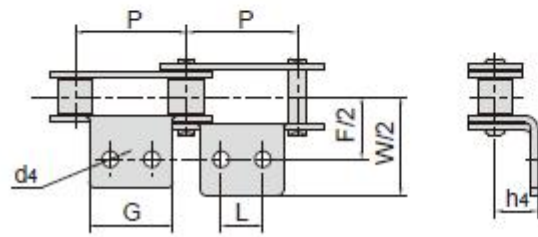

K2

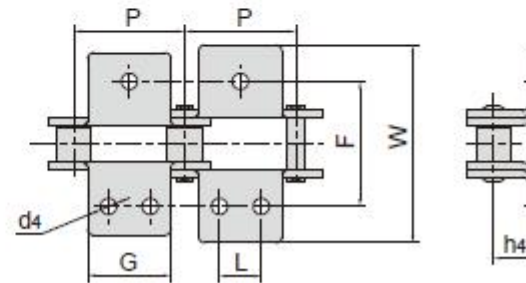



HANGZHOU OCEAN INDUSTRY CO., LTD.

| Chain No. | P | G | L | F | W | h4 | d4 |
|---------------|-------|-------|-------|-------|--------|-------|-------|
| | mm | mm | mm | mm | mm | mm | mm |
| C 2060HA2F26 | 38.10 | 46.00 | 32.00 | 42.0 | 56.00 | 15.70 | 5.50 |
| C 2060HF3A2 | 38.10 | 28.60 | 14.30 | 42.9 | 67.80 | 14.70 | 5.20 |
| C 2060HK 1F | 38.10 | 28.60 | - | 42.9 | 67.80 | 14.70 | 8.00 |
| C 2060HK 1F22 | 38.10 | 28.60 | - | 42.9 | 67.80 | 14.70 | 8.50 |
| C 2060HK 1F26 | 38.10 | 28.60 | - | 42.9 | 67.80 | 14.70 | 9.20 |
| C 2060HK 1F33 | 38.10 | 28.60 | - | 42.9 | 67.80 | 14.70 | 8.90 |
| C 2060HK 2F3 | 38.10 | 28.60 | 14.30 | 42.9 | 64.80 | 14.70 | 5.00 |
| C 2060HK 2F94 | 38.10 | 28.00 | 14.30 | 42.8 | 60.40 | 14.70 | 5.60 |
| C 2060K 1F1 | 38.10 | 28.60 | - | 42.9 | 68.00 | 14.70 | 8.50 |
| C 2060K 1F3 | 38.10 | 76.20 | - | 104.7 | 151.60 | 36.50 | 13.10 |
| C 2060K 1F32 | 38.10 | 29.00 | - | 43.5 | 63.50 | 14.85 | 8.50 |
| C 2062A 1F13 | 38.10 | 30.00 | - | 70.2 | 98.00 | 14.70 | 8.50 |
| C 2062A 1F36 | 38.10 | 28.60 | - | 42.9 | 67.80 | 12.50 | 6.80 |
| C 2062A 2F22 | 38.10 | 28.60 | 14.30 | 42.9 | 57.40 | 14.70 | 5.50 |
| C 2062A 2F24 | 38.10 | 28.60 | 14.30 | 42.9 | 67.80 | 14.70 | 4.76 |
| C 2062A 2F6 | 38.10 | 28.60 | 14.30 | 42.9 | 67.80 | 14.70 | 6.00 |
| C 2062HA 1F25 | 38.10 | 28.00 | - | 59.0 | 75.00 | 9.00 | 6.00 |
| C 2062HA 1F4 | 38.10 | 20.00 | - | 45.8 | 65.80 | 9.00 | 6.80 |
| C 2062HA 1F7 | 38.10 | 28.60 | - | 42.9 | 67.80 | 14.70 | 5.20 |
| C 2062HA 2F18 | 38.10 | 28.60 | 14.30 | 42.2 | 57.00 | 14.70 | 5.50 |
| C 2062HA 2F7 | 38.10 | 28.60 | 14.30 | 42.9 | 67.80 | 14.70 | 6.50 |
| C 2062HF 15 | 38.10 | 28.60 | 14.30 | 42.9 | 67.80 | 14.70 | M 5 |
| C 2062HK 1F5 | 38.10 | 28.60 | - | 42.9 | 67.80 | 14.70 | 7.90 |
| C 2062HK 2F4 | 38.10 | 28.60 | 14.30 | 42.9 | 56.40 | 14.70 | 5.20 |
| C 2062HK 2F5 | 38.10 | 28.60 | 14.30 | 55.6 | 76.00 | 11.10 | 5.50 |
| C 2062K 2F7 | 38.10 | 28.60 | 14.30 | 42.9 | 67.80 | 14.70 | 6.50 |
| C 2080A 1F78 | 50.80 | 38.10 | - | 55.6 | 87.80 | 19.10 | 6.50 |

A1

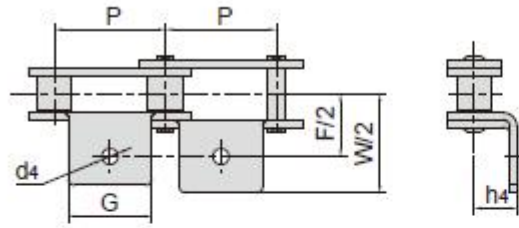

K1

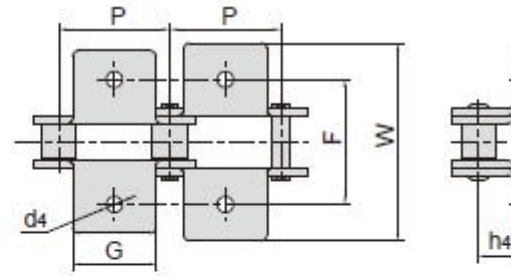

A2

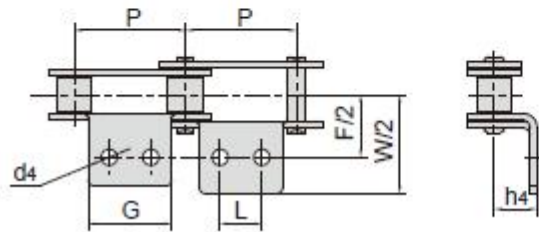

K2

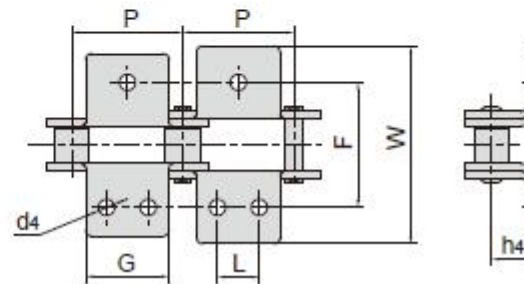



HANGZHOU OCEAN INDUSTRY CO., LTD.

| Chain No. | P | G | L | F | W | h4 | d4 |
|---------------|-------|-------|-------|------|-------|-------|------------|
| | mm | mm | mm | mm | mm | mm | mm |
| C 2080A2F78 | 50.80 | 64.00 | 40.00 | 68.0 | 88.00 | 30.00 | 9.00 |
| C 2080HA2F12 | 50.80 | 38.10 | 19.10 | 55.6 | 73.00 | 19.10 | 8.10 |
| C 2080HF | 50.80 | 38.10 | 19.10 | 55.6 | 75.20 | 17.80 | 10.00 |
| C 2080HK 1F13 | 50.80 | 38.10 | - | 55.6 | 80.00 | 19.10 | 9.00 |
| C 2080HK 1F24 | 50.80 | 38.10 | - | 55.6 | 87.80 | 19.10 | 11.11×7.94 |
| C 2080HK 1F8 | 50.80 | 38.10 | - | 55.6 | 87.80 | 19.10 | 9.00 |
| C 2082A1F22 | 50.80 | 38.10 | - | 49.6 | 76.20 | 16.00 | 10.50 |
| C 2082A1F79 | 50.80 | 39.00 | - | 59.0 | 78.50 | 23.00 | 7.00 |
| C 2082A2F1 | 50.80 | 39.00 | 19.00 | 58.0 | 82.00 | 21.50 | 7.00 |
| C 2082A2F2 | 50.80 | 39.00 | 19.00 | 58.0 | 82.00 | 21.50 | 10.00 |
| C 2082A2F23 | 50.80 | 65.00 | 44.00 | 62.0 | 86.00 | 19.40 | 7.00 |
| C 2082A2F26 | 50.80 | 40.00 | 18.00 | 62.0 | 86.00 | 19.10 | 7.00 |
| C 2082A2F27 | 50.80 | 38.10 | 19.10 | 55.6 | 87.80 | 19.10 | 8.20 |
| C 2082F64K2 | 50.80 | 34.90 | 20.00 | 54.0 | 79.00 | 16.00 | M 6 |
| C 2082F88K1 | 50.80 | 35.00 | - | 60.0 | 79.00 | 16.50 | 8.00 |
| C 2082HA 1F17 | 50.80 | 38.10 | - | 55.6 | 87.80 | 19.10 | 9.50 |
| C 2082HA 1F21 | 50.80 | 38.10 | - | 55.6 | 88.30 | 19.10 | 10.20 |
| C 2082HA 1F6 | 50.80 | 38.10 | - | 55.6 | 77.80 | 19.10 | 10.00 |
| C 2082HA 1F76 | 50.80 | 38.10 | - | 55.6 | 87.80 | 19.10 | 8.50 |
| C 2082HA 1F78 | 50.80 | 38.10 | - | 55.6 | 87.80 | 19.10 | M 8 |
| C 2082HA2F22 | 50.80 | 60.00 | 40.00 | 62.6 | 82.60 | 39.50 | 9.00 |
| C 2082HA2F6 | 50.80 | 38.10 | 19.10 | 55.6 | 87.80 | 19.10 | 8.00 |
| C 2082HA2F77 | 50.80 | 38.10 | 19.10 | 55.6 | 87.80 | 19.10 | 8.50 |
| C 2082HHA 1F4 | 50.80 | 38.10 | - | 55.6 | 87.80 | 19.10 | 9.50 |
| C 2082HHA 1F5 | 50.80 | 38.10 | - | 55.6 | 87.80 | 19.10 | 10.50 |

A1

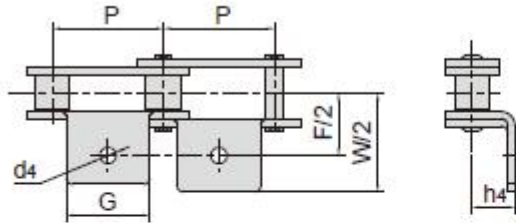

A2

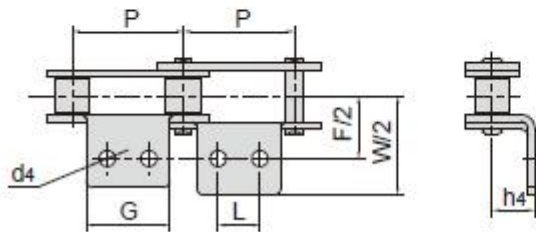

K1

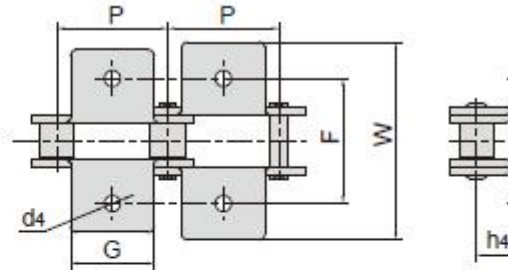

K2

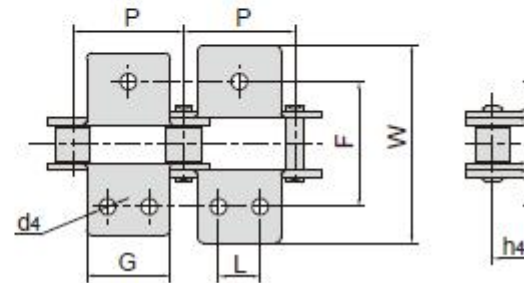



HANGZHOU OCEAN INDUSTRY CO., LTD.

| Chain No. | P | G | L | F | W | h4 | d4 |
|----------------|--------|-------|-------|-------|--------|-------|-------|
| | mm | mm | mm | mm | mm | mm | mm |
| C 2082HK 1F23 | 50.80 | 38.10 | - | 55.6 | 87.80 | 19.10 | 8.00 |
| C 2082HK 1F5 | 50.80 | 38.10 | - | 55.6 | 79.60 | 19.10 | 8.00 |
| C 2082HK 1F7 | 50.80 | 38.10 | - | 55.6 | 79.60 | 19.10 | 6.50 |
| C 2082HK 1F79 | 50.80 | 50.80 | - | 55.6 | 87.80 | 19.10 | 6.80 |
| C 2082HK 1F80 | 50.80 | 38.10 | - | 55.6 | 87.80 | 19.10 | 6.00 |
| C 2082HK 1F81 | 50.80 | 38.10 | - | 55.6 | 87.80 | 19.10 | 8.20 |
| C 2082HK 1F9 | 50.80 | 38.10 | - | 55.6 | 81.50 | 19.10 | M 8 |
| C 2082K 2F5 | 50.80 | 38.10 | 19.10 | 120.0 | 140.00 | 19.10 | 6.80 |
| C 216BA2F9 | 50.80 | 42.00 | 25.40 | 50.8 | 70.80 | 18.00 | 6.20 |
| C 2100HK 1F1 | 63.50 | 47.60 | - | 66.0 | 92.00 | 25.00 | 12.50 |
| C 2102HA 1F16 | 63.50 | 47.60 | - | 66.6 | 107.50 | 23.40 | 11.20 |
| C 2102HA 1F3 | 63.50 | 47.60 | - | 66.0 | 96.60 | 23.40 | 12.40 |
| C 2102HA 1F4 | 63.50 | 47.60 | - | 66.6 | 107.50 | 23.40 | 10.00 |
| C 2102HA 2F3 | 63.50 | 47.60 | 23.80 | 66.6 | 99.80 | 23.40 | 3/8" |
| C 2102HA 2F4 | 63.50 | 47.60 | 23.80 | 66.6 | 107.50 | 23.40 | 10.00 |
| C 220AHA 2F2 | 63.50 | 47.60 | 23.80 | 66.6 | 107.50 | 23.40 | 9.20 |
| C 220AHK 1F1 | 63.50 | 47.60 | - | 66.0 | 92.00 | 25.00 | 12.50 |
| C 220ALA 1F11 | 63.50 | 47.60 | - | 66.6 | 107.40 | 23.40 | 9.20 |
| C 220ALA 1F5 | 63.50 | 47.60 | - | 76.6 | 107.50 | 23.40 | 11.00 |
| C 220ALA 1F8 | 63.50 | 47.60 | - | 66.6 | 107.40 | 23.40 | 8.70 |
| C 220ALA 1F9 | 63.50 | 47.60 | - | 68.6 | 109.60 | 23.40 | M 8 |
| C 220ALA 2F5 | 63.50 | 52.00 | 31.00 | 66.6 | 107.40 | 23.40 | 9.20 |
| C 2122HA 1F3 | 76.20 | 57.20 | - | 79.3 | 121.58 | 27.80 | 14.00 |
| C 224AHA 2F9 | 76.20 | 72.00 | 40.00 | 79.3 | 121.40 | 27.80 | 13.00 |
| C 224AHK 2F2 | 76.20 | 72.00 | 40.00 | 79.3 | 121.40 | 27.80 | 13.00 |
| C 2162A 2F1 | 101.60 | 76.20 | 38.10 | 104.7 | 151.50 | 36.50 | 18.00 |
| C 2162HA 2F2 | 101.60 | 36.50 | 38.10 | 104.7 | 151.60 | 36.50 | 18.00 |
| C 2162HA 2F3 | 101.60 | 76.20 | 38.10 | 120.0 | 167.00 | 36.50 | 13.10 |
| C 2162HF 1A2 | 101.60 | 76.20 | 38.10 | 104.6 | 151.60 | 36.50 | 13.10 |
| C 2162HK 1-M 8 | 101.60 | 76.20 | - | 110.0 | 149.60 | 37.50 | M 8 |

AA1

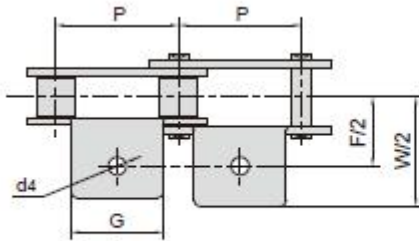

AA2

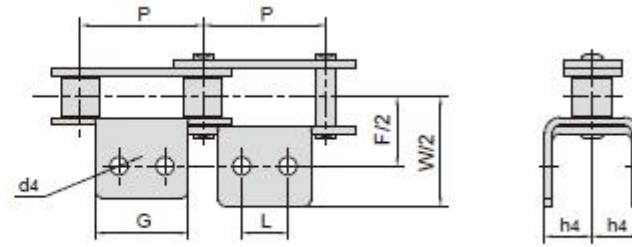

KK1

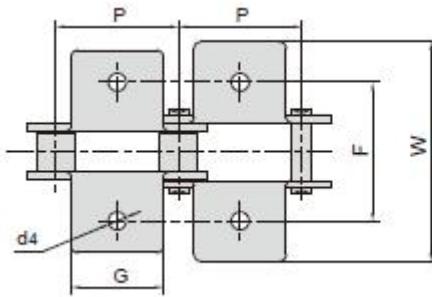

KK2

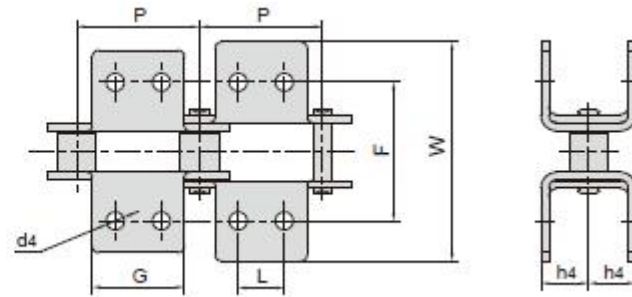



HANGZHOU OCEAN INDUSTRY CO., LTD.

| Chain No. | ANSI 链号 ANSI Chain No. | P | G | L | F | W | h ₄ | d ₄ |
|---------------------|---------------------------------|-------|------|------|------|-------|----------------|----------------|
| | | mm | mm | mm | mm | mm | mm | mm |
| C 208A C 208AL | C 2040 C 2042 | 25.40 | 19.1 | 9.5 | 25.4 | 39.6 | 9.10 | 3.4 |
| C 208B C 208BL | | 25.40 | 23.2 | 12.7 | 25.4 | 39.6 | 9.10 | 4.5 |
| C 210A C 210AL | C 2050 C 2052 | 31.75 | 23.8 | 11.9 | 31.8 | 49.0 | 11.10 | 5.5 |
| C 212A C 212AL | C 2060 C 2062 | 38.10 | 28.6 | 14.3 | 42.9 | 67.8 | 14.70 | 5.5 |
| C 212AH C 212AHL | C 2060H C 2062H | 38.10 | 28.6 | 14.3 | 42.9 | 67.8 | 14.70 | 5.5 |
| C 216A C 216AL | C 2080 C 2082 | 50.80 | 38.1 | 19.1 | 55.6 | 87.8 | 19.10 | 6.8 |
| C 216AH C 216AHL | C 2080H C 2082H | 50.80 | 38.1 | 19.1 | 55.6 | 87.8 | 19.10 | 6.8 |
| 100HAA 1F1 | | 31.75 | 35.0 | - | 71.2 | 93.4 | 35.75 | 8.0 |
| A2050AA 1F1 | | 31.75 | 20.0 | - | 47.0 | 66.0 | 35.50 | 8.1 |
| 2060AA 2F1 | | 38.10 | 38.1 | 19.0 | 37.5 | 57.5 | 14.80 | 6.5 |
| C 2062AA 1F1 | | 38.10 | 14.0 | - | 33.4 | 52.0 | 9.00 | 6.4 |
| C 2080K 1F4 | | 50.80 | 38.1 | - | 80.0 | 112.0 | 15.30 | 8.5 |
| C 2082HAA 1F1 | | 50.80 | 25.0 | - | 78.8 | 128.8 | 17.50 | 8.0 |
| C 2082HAA 1F2 | | 50.80 | 25.0 | - | 77.8 | 127.8 | 17.50 | 12.0 |
| C 2100HF6AA 1 | | 63.50 | 47.8 | - | 68.0 | 100.0 | 23.40 | 10.0 |
| C 2120AA 1F1 | | 76.20 | 31.8 | - | 88.7 | 115.6 | 35.00 | 10.5 |
| C 2122HAA 1 | | 76.20 | 57.2 | - | 79.3 | 121.4 | 27.80 | 11.0 |

SA1

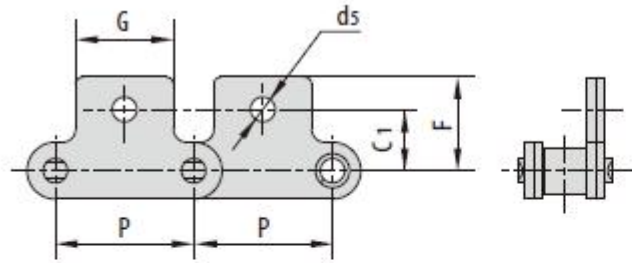

SK1

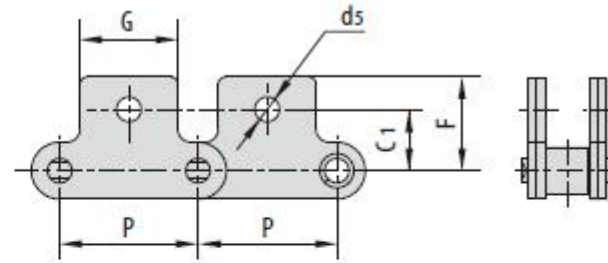

SA2

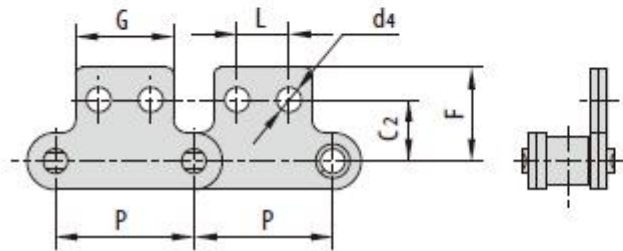

SK2

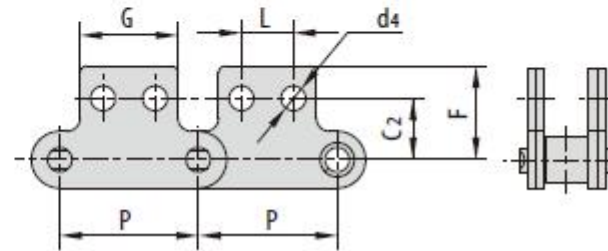



HANGZHOU OCEAN INDUSTRY CO., LTD.

| Chain No. | ANSI 链号 ANSI Chain No. | P | G | L | C ₁ | C ₂ | F | d ₄ | d ₅ |
|----------------|---------------------------------|-------|-------|-------|----------------|----------------|------|----------------|----------------|
| | | mm | mm | mm | mm | mm | mm | mm | mm |
| C 208A | C 2040 | 25.40 | 19.10 | 9.50 | 11.1 | 13.50 | 20.5 | 3.4 | 5.50 |
| C 208AL | C 2042 | | | | | | | | |
| C 208B | | 25.40 | 23.20 | 12.70 | 11.1 | 13.50 | 20.5 | 4.5 | 5.50 |
| C 208BL | | | | | | | | | |
| C 210A | C 2050 | 31.75 | 23.80 | 11.90 | 14.3 | 15.90 | 25.0 | 5.5 | 6.60 |
| C 210AL | C 2052 | | | | | | | | |
| C 212A | C 2060 | 38.10 | 28.60 | 14.30 | 17.5 | 19.10 | 32.9 | 5.5 | 9.20 |
| C 212AL | C 2062 | | | | | | | | |
| C 212AH | C 2060H | 38.10 | 28.60 | 14.30 | 17.5 | 19.10 | 32.9 | 5.5 | 9.20 |
| C 212AHL | C 2062H | | | | | | | | |
| C 216A | C 2080 | 50.80 | 38.10 | 19.10 | 22.2 | 25.40 | 43.5 | 6.6 | 11.00 |
| C 216AL | C 2082 | | | | | | | | |
| C 216AH | C 2080H | 50.80 | 38.10 | 19.10 | 22.2 | 25.40 | 43.5 | 6.6 | 11.00 |
| C 216AHL | C 2082H | | | | | | | | |
| C 220A | C 2100 | 63.50 | 47.60 | 23.80 | 28.6 | 31.80 | 50.4 | 8.4 | 13.00 |
| C 220AL | C 2102 | | | | | | | | |
| C 220AH | C 2100H | 63.50 | 47.60 | 23.80 | 28.6 | 31.80 | 50.4 | 8.4 | 13.00 |
| C 220AHL | C 2102H | | | | | | | | |
| C 2042HW SA2 | | 25.40 | 37.30 | 9.50 | - | 13.50 | 20.5 | 3.4 | - |
| C 2050HW SA2F1 | | 31.75 | 46.75 | 31.75 | - | 15.90 | 25.0 | 5.5 | - |
| C 2060SA2F1 | | 38.10 | 28.60 | 14.30 | - | 19.10 | 26.1 | 5.5 | - |
| C 2062H SK2F1 | | 38.10 | 28.60 | 14.30 | - | 19.10 | 23.8 | 5.2 | - |
| C 2060H SK1F1 | | 38.10 | 28.60 | - | 17.3 | - | 30.0 | - | 11.80 |
| C 216AH2F | | 50.80 | 38.10 | 19.10 | - | 25.40 | 43.5 | 6.5 | - |
| C 2082F58SA1 | | 50.80 | 38.50 | - | 27.0 | - | 39.5 | - | 8.10 |
| C 2100H SA1 | | 63.50 | 47.60 | - | 28.6 | - | 50.4 | - | 13.00 |
| C 224ALSK2F1 | | 76.20 | 57.20 | 28.60 | - | 37.30 | 59.9 | - | 11.00 |
| C 2122H SA1F1 | | 76.20 | 57.20 | - | 37.3 | - | 59.9 | - | 14.30 |
| C 224AHL SA2F1 | | 76.20 | 57.20 | 28.60 | - | 37.30 | 59.9 | - | 9.53 |
| 208BSK1F2 | | 25.40 | 14.00 | - | 17.7 | - | 21.3 | - | 3.20 |
| 208BSK1F3 | | 25.40 | 13.00 | - | 14.7 | - | 26.7 | - | 3.10 |
| 208BSK1F4 | | 25.40 | 24.20 | - | 14.3 | - | 20.5 | - | 4.20 |

SA1

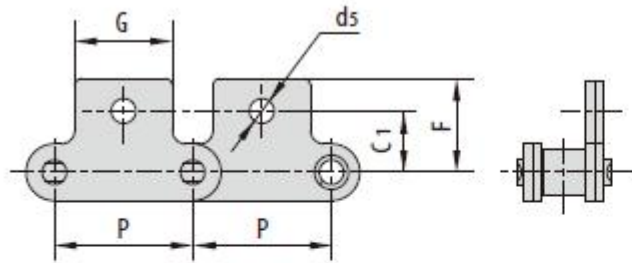

SK1

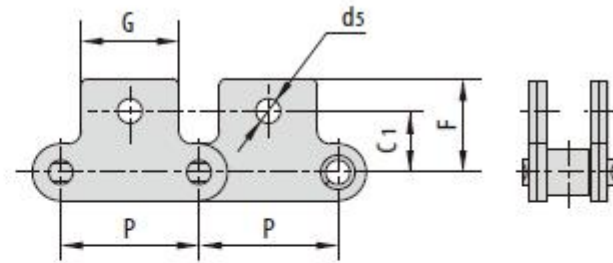

SA2

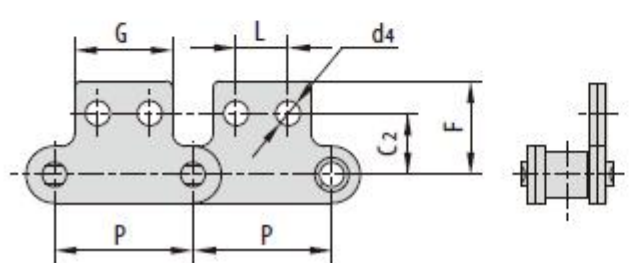

SK2

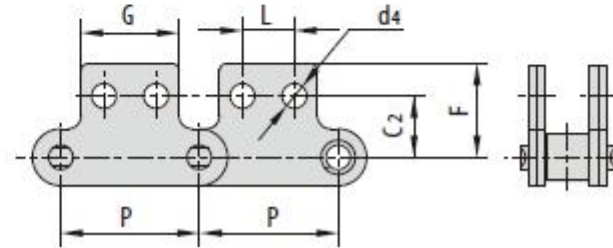



HANGZHOU OCEAN INDUSTRY CO., LTD.

| Chain No. | P | G | L | C ₁ | C ₂ | F | d ₄ | d ₅ |
|----------------|--------|-------|-------|----------------|----------------|-------|----------------|----------------|
| | mm | mm | mm | mm | mm | mm | mm | mm |
| C 2040F23SK0 | 25.40 | 19.10 | - | - | - | 25.70 | - | - |
| C 208B SK 2F2 | 25.40 | 23.20 | 12.70 | - | 13.02 | 20.17 | 4.50 | - |
| C 208B SA2F2 | 25.40 | 31.80 | 22.00 | - | 18.30 | 22.80 | 4.50 | - |
| C 2050SK 1F2 | 31.75 | 24.80 | - | 17.00 | - | 36.00 | - | 15.00 |
| C 2050SA0F6 | 31.75 | 46.75 | - | - | - | 15.50 | - | - |
| C 210B SA2F3 | 31.75 | 30.00 | 18.00 | - | 21.00 | 28.00 | 5.50 | - |
| C 2060H SF6SK2 | 38.10 | 28.60 | 14.30 | - | 19.10 | 32.90 | 6.50 | - |
| C 2062H SA 1F2 | 38.10 | 28.60 | - | 17.50 | - | 30.50 | - | 8.30 |
| C 2060SK0F4 | 38.10 | 20.00 | - | - | - | 49.00 | - | - |
| C 2082SA 1F2 | 50.80 | 38.10 | - | 27.70 | - | 39.70 | - | 8.20 |
| C 2080HF91 | 50.80 | 38.10 | - | - | - | 43.50 | - | - |
| C 220AH SA2F1 | 63.50 | 47.60 | 23.80 | - | 31.80 | 50.40 | 8.70 | - |
| C 224ALSK2F2 | 76.20 | 57.20 | 28.60 | - | 37.50 | 52.50 | 12.50 | - |
| C 224AH SK 1F2 | 76.20 | 57.20 | - | 43.80 | - | 59.02 | - | 17.60 |
| C 224AHLSA2F2 | 76.20 | 57.00 | 28.60 | - | 37.30 | 58.90 | 11.00 | - |
| C 2160H SK0F1 | 101.60 | 40.00 | - | - | - | 17.50 | - | - |